

# HARDMETALS

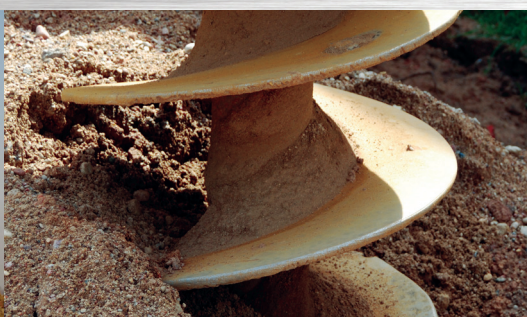

## CONSTRUCTION AUGERS & DRILLING TOOLS



# CONTENTS

Contents.....	1
Company Overview .....	2
EM Auger Tools & Accessories .....	3
EM & CP Rock & Earth Augers .....	4
CP Construction Tools .....	5
Class Description .....	6
EM & CP Rock & Earth Augers .....	7
Augers S/F Rock Conical Pick Style .....	8
Augers L/F Rock Conical Pick Style .....	9
Augers S/F Rock Taper Lock Style.....	11
Augers L/F Rock Taper Lock Style .....	12
Augers S/F Rock Flat Tooth Style.....	13
Augers L/F Rock Flat Tooth Style .....	14
Auger Heads.....	15
Auger Rods.....	16
EM &CP Auger Tools & Accessories.....	17
Conical Pick Blocks .....	18
Conical Extraction Tools .....	19
Conical Picks.....	20
Conical Pick - 55.....	20
Conical Pick- 74.....	20
Conical Pick- 76.....	21
Conical Pick- 86.....	22
Wear Protection Weld On Teeth .....	23
EMF Flat & Fishtail Auger Parts .....	24
Flat Cutter Picks & Blocks .....	26
Taper Fit Auger Teeth.....	27
Centre Bits.....	28
Drive Pin Location Bush .....	31
Proline Tools.....	31
Taper Holders.....	32
EM Holders.....	33
Rock Bits .....	34
Wing Bits .....	35

## COMPANY OVERVIEW

Hard Metals Australia Pty Limited (HMA) is a precision engineering company specialising in the design and manufacture of Tungsten Carbide and Polycrystalline diamond tools for the drilling, construction, mining and agricultural industries. Formed in 1982 as Australasian distributor for a world leading Tungsten Carbide Manufacture, HMA was instrumental in the development and application of Tungsten Carbide for agricultural ground engaging tools during the 80's and early 90's. Since then our range of products have significantly increased.

HMA now manufactures tungsten carbide tools for:

- Mining and Exploration
- Foundation and Piling Drilling Tools.
- Trenching and Road Profiling Tools
- Horizontal Directional Drilling
- Agricultural Tillage Tools
- Forestry and Recycling Industry Tools
- Special or Custom Designed Wear Parts

## EM AUGER TOOLS & ACCESSORIES

EM auger tools and accessories are compatible with most popular systems in the market place. These include:

- Conical Picks Systems (For an extended range, see CP Tools)
- Taper Lock Tooth
- Flat Cutter Picks
- Threaded and Hex Shank Pilots

HMA Augers are manufactured in Australia under strict quality controlled conditions using premium materials. These tools are suitable for light to medium duty machines in both earth and rock applications.

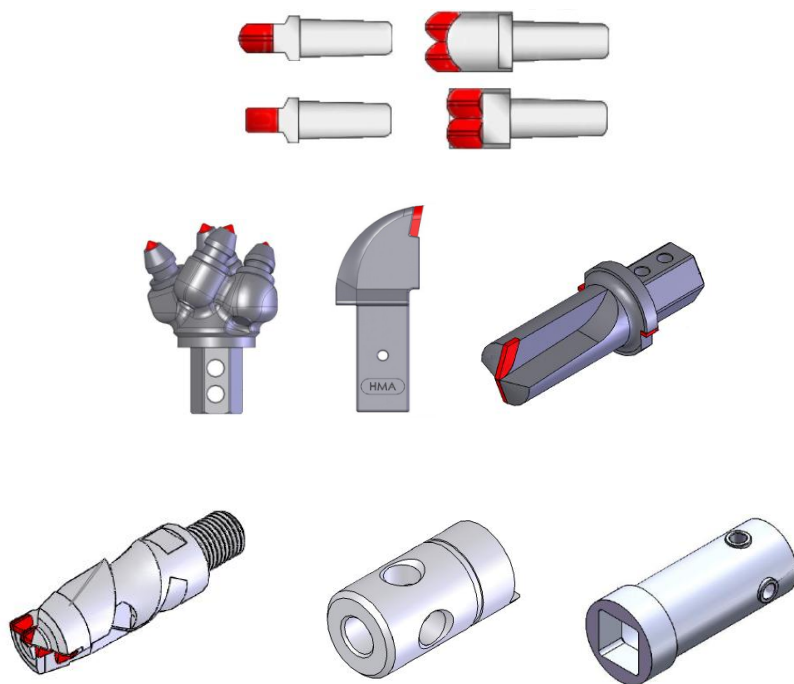

## EM & CP ROCK & EARTH AUGERS

Made locally with fully welded 16mm flight as a minimum standard and our proprietary tool settings, HMA augers are designed and manufactured to suit the user that demands superior performance in all ground conditions.

Auger types include rock and earth type using either of the following tooling systems

- CP conical pick or rotating pick tooling.
- EM taper lock tooling.
- Flat cutter picks.

Generally suited to medium machines, heavy-duty augers can be manufactured for larger machines and tougher applications.

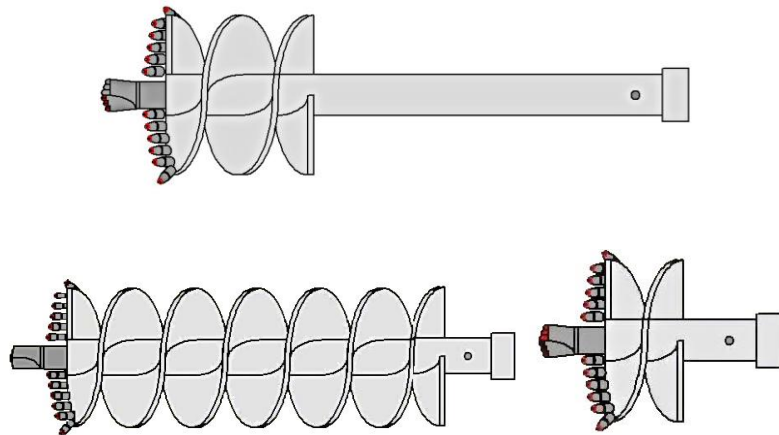

## CP CONSTRUCTION TOOLS

The range covers the following series/shank sizes

- 0.55" – 14.0mm shanks
- 0.74" – 18.8mm shanks
- 0.76" – 19.3mm shanks
- 0.86" – 21.8mm shanks
- 0.99" – 25.0mm shanks
- 1.16" – 29.5mm stepped shanks
- 1.18" – 30mm straight shanks

Associated products include holders and pick removing tools. These tools provide a very economical and durable solution for many tooling applications.

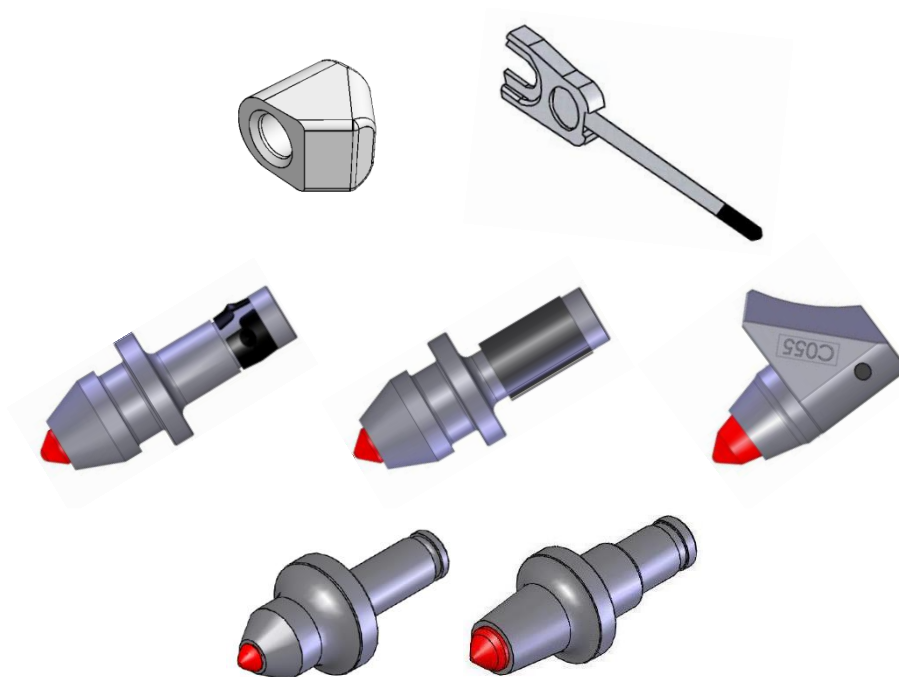

## CLASS DESCRIPTION

STOCK CODE	DESCRIPTION
1	Standard Stock Item / Min Stock is required to be kept on hand
3	Irregular Stock Item / Minimum order quantity may be required
6	New Stock Item / Stock code undefined
8	Non Stock Item / Minimum quantity required

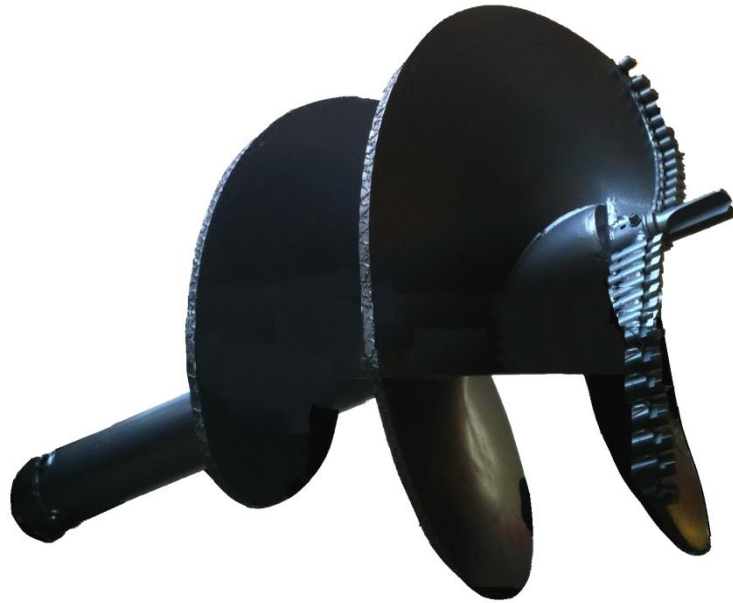

## *EM & CP ROCK & EARTH AUGERS*



## AUGERS S/F ROCK CONICAL PICK Style\*

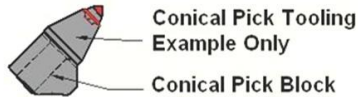
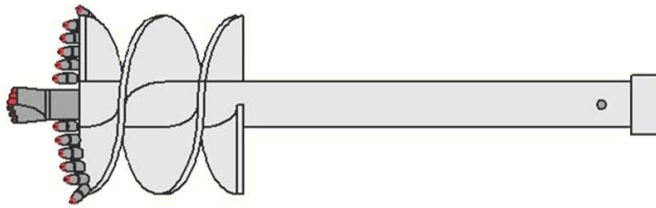

Auger Diameter	Lead Flight	Carry Flight
300mm - 500mm	16mm	12mm
600mm - 900mm	20mm	16mm (N/A on 900mm)
1200mm - 1500mm	25mm	N/A

\* For spare parts please refer to EM Auger Tools & Accessories Section

### Designation System

Part Number	Stock Code	Description
<b>EMA300SFR-CP</b>	8	Auger S/F Rock D=300mm CP Style
<b>EMA350SFR-CP</b>	8	Auger S/F Rock D=350mm CP Style
<b>EMA400SFR-CP</b>	8	Auger S/F Rock D=400mm CP Style
<b>EMA450SFR-CP</b>	8	Auger S/F Rock D=450mm CP Style
<b>EMA500SFR-CP</b>	8	Auger S/F Rock D=500mm CP Style
<b>EMA550SFR-CP</b>	8	Auger S/F Rock D=550mm CP Style
<b>EMA600SFR-CP</b>	8	Auger S/F Rock D=600mm CP Style
<b>EMA650SFR-CP</b>	8	Auger S/F Rock D=650mm CP Style
<b>EMA700SFR-CP</b>	8	Auger S/F Rock D=700mm CP Style
<b>EMA750SFR-CP</b>	8	Auger S/F Rock D=750mm CP Style
<b>EMA800SFR-CP</b>	8	Auger S/F Rock D=800mm CP Style
<b>EMA900SFR-CP</b>	8	Auger S/F Rock D=900mm CP Style
<b>EMA1000SFR-CP</b>	8	Auger S/F Rock D=1000mm CP Style
<b>EMA1200SFR-CP</b>	8	Auger S/F Rock D=1200mm CP Style

*~ All sizes can be made to customer's requirements ~*

## AUGERS L/F ROCK CONICAL PICK Style\*

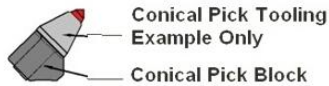
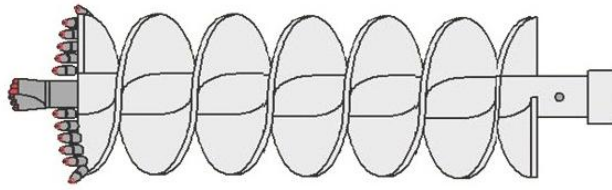

Auger Diameter	Lead Flight	Carry Flight
300mm - 500mm	16mm	12mm
600mm - 900mm	20mm	16mm (N/A on 900mm)
1200mm - 1500mm	25mm	N/A

\* For spare parts please refer to EM Auger Tools & Accessories Section

### Designation System

Part Number	Stock Code	Description
EMA300LFR-CP	8	Auger L/F Rock D=300mm CP Style
EMA350LFR-CP	8	Auger L/F Rock D=350mm CP Style
EMA400LFR-CP	8	Auger L/F Rock D=400mm CP Style
EMA450LFR-CP	8	Auger L/F Rock D=450mm CP Style
EMA500LFR-CP	8	Auger L/F Rock D=500mm CP Style
EMA550LFR-CP	8	Auger L/F Rock D=550mm CP Style
EMA600LFR-CP	8	Auger L/F Rock D=600mm CP Style
EMA650LFR-CP	8	Auger L/F Rock D=650mm CP Style
EMA700LFR-CP	8	Auger L/F Rock D=700mm CP Style
EMA750LFR-CP	8	Auger L/F Rock D=750mm CP Style
EMA800LFR-CP	8	Auger L/F Rock D=800mm CP Style
EMA900LFR-CP	8	Auger L/F Rock D=900mm CP Style
EMA1000LFR-CP	8	Auger L/F Rock D=1000mm CP Style
EMA1200LFR-CP	8	Auger L/F Rock D=1200mm CP Style

~ All sizes can be made to customer's requirements ~

## AUGERS L/F ROCK CONICAL PICK Style\*

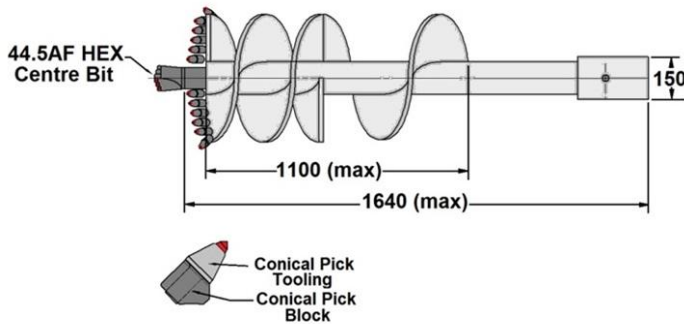

Auger Diameter	Lead Flight	Carry Flight
300mm - 500mm	16mm	12mm
600mm - 900mm	20mm	16mm (N/A on 900mm)
1200mm - 1500mm	25mm	N/A

\* For spare parts please refer to EM Auger Tools & Accessories Section

### Designation System

Part Number	Stock Code	Description
EMA300LFR-CPA	8	Auger L/F Rock D=300mm CP Style
EMA350LFR-CPA	8	Auger L/F Rock D=350mm CP Style
EMA400LFR-CPA	8	Auger L/F Rock D=400mm CP Style
EMA450LFR-CPA	8	Auger L/F Rock D=450mm CP Style
EMA500LFR-CPA	8	Auger L/F Rock D=500mm CP Style
EMA550LFR-CPA	8	Auger L/F Rock D=550mm CP Style
EMA600LFR-CPA	8	Auger L/F Rock D=600mm CP Style
EMA650LFR-CPA	8	Auger L/F Rock D=650mm CP Style
EMA700LFR-CPA	8	Auger L/F Rock D=700mm CP Style
EMA750LFR-CPA	8	Auger L/F Rock D=750mm CP Style
EMA800LFR-CPA	8	Auger L/F Rock D=800mm CP Style
EMA900LFR-CPA	8	Auger L/F Rock D=900mm CP Style
EMA1000LFR-CPA	8	Auger L/F Rock D=1000mm CP Style
EMA1200LFR-CPA	8	Auger L/F Rock D=1200mm CP Style

~ All sizes can be made to customer's requirements ~

## AUGERS S/F ROCK TAPER LOCK STYLE\*

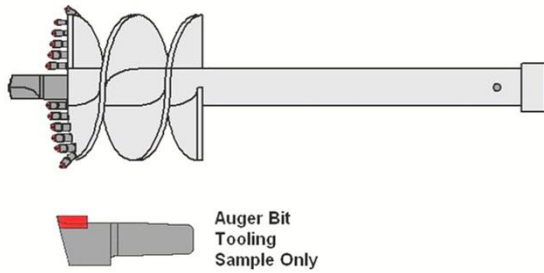

Auger Diameter	Lead Flight	Carry Flight
300mm - 500mm	16mm	12mm
600mm - 900mm	20mm	16mm (N/A on 900mm)
1200mm - 1500mm	25mm	N/A

\* For spare parts please refer to EM Auger Tools & Accessories Section

### Designation System

Part Number	Stock Code	Description
EMA300SFR-TL	8	Auger S/F Rock D=300mm TL Style
EMA350SFR-TL	8	Auger S/F Rock D=350mm TL Style
EMA400SFR-TL	8	Auger S/F Rock D=400mm TL Style
EMA450SFR-TL	8	Auger S/F Rock D=450mm TL Style
EMA500SFR-TL	8	Auger S/F Rock D=500mm TL Style
EMA550SFR-TL	8	Auger S/F Rock D=550mm TL Style
EMA600SFR-TL	8	Auger S/F Rock D=600mm TL Style
EMA650SFR-TL	8	Auger S/F Rock D=650mm TL Style
EMA700SFR-TL	8	Auger S/F Rock D=700mm TL Style
EMA750SFR-TL	8	Auger S/F Rock D=750mm TL Style
EMA800SFR-TL	8	Auger S/F Rock D=800mm TL Style
EMA900SFR-TL	8	Auger S/F Rock D=900mm TL Style
EMA1000SFR-TL	8	Auger S/F Rock D=1000mm TL Style
EMA1200SFR-TL	8	Auger S/F Rock D=1200mm TL Style

~ All sizes can be made to customer's requirements ~

## AUGERS L/F ROCK TAPER LOCK STYLE\*

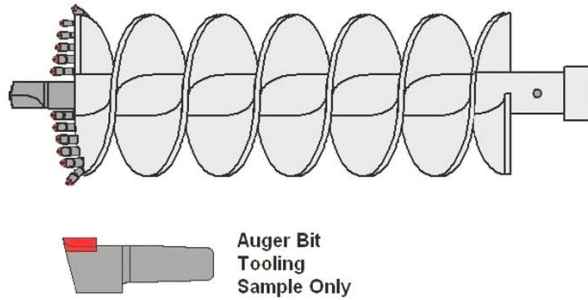

Auger Diameter	Lead Flight	Carry Flight
300mm - 500mm	16mm	12mm
600mm - 900mm	20mm	16mm (N/A on 900mm)
1200mm - 1500mm	25mm	N/A

\* For spare parts please refer to EM Auger Tools & Accessories Section

### Designation System

Part Number	Stock Code	Description
EMA300LFR-TL	8	Auger L/F Rock D=300mm TL Style
EMA350LFR-TL	8	Auger S/F Rock D=350mm TL Style
EMA400LFR-TL	8	Auger L/F Rock D=400mm TL Style
EMA450LFR-TL	8	Auger L/F Rock D=450mm TL Style
EMA500LFR-TL	8	Auger L/F Rock D=500mm TL Style
EMA550LFR-TL	8	Auger L/F Rock D=550mm TL Style
EMA600LFR-TL	8	Auger L/F Rock D=600mm TL Style
EMA650LFR-TL	8	Auger L/F Rock D=650mm TL Style
EMA700LFR-TL	8	Auger L/F Rock D=700mm TL Style
EMA750LFR-TL	8	Auger L/F Rock D=750mm TL Style
EMA800LFR-TL	8	Auger L/F Rock D=800mm TL Style
EMA900LFR-TL	8	Auger S/F Rock D=900mm TL Style
EMA1000LFR-TL	8	Auger L/F Rock D=1000mm TL Style
EMA1200LFR-TL	8	Auger L/F Rock D=1200mm TL Style

~ All sizes can be made to customer's requirements ~

## AUGERS S/F ROCK FLAT TOOTH STYLE\*

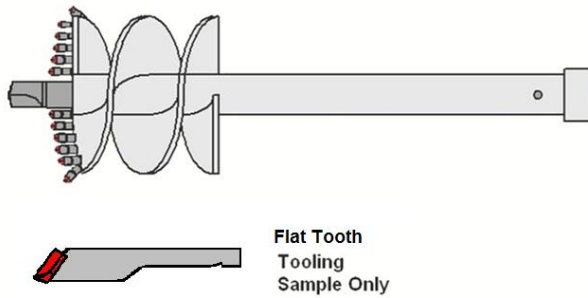

Auger Diameter	Lead Flight	Carry Flight
300mm - 500mm	16mm	12mm
600mm - 900mm	20mm	16mm (N/A on 900mm)
1200mm - 1500mm	25mm	N/A

\* For spare parts please refer to EM Auger Tools & Accessories Section

### Designation System

Part Number	Stock Code	Description
EMA300SFR-FT	8	Auger S/F Rock D=300mm FT Style
EMA350SFR-FT	8	Auger S/F Rock D=350mm FT Style
EMA400SFR-FT	8	Auger S/F Rock D=400mm FT Style
EMA450SFR-FT	8	Auger S/F Rock D=450mm FT Style
EMA500SFR-FT	8	Auger S/F Rock D=500mm FT Style
EMA550SFR-FT	8	Auger S/F Rock D=550mm FT Style
EMA600SFR-FT	8	Auger S/F Rock D=600mm FT Style
EMA650SFR-FT	8	Auger S/F Rock D=650mm FT Style
EMA700SFR-FT	8	Auger S/F Rock D=700mm FT Style
EMA750SFR-FT	8	Auger S/F Rock D=750mm FT Style
EMA800SFR-FT	8	Auger S/F Rock D=800mm FT Style
EMA900SFR-FT	8	Auger S/F Rock D=900mm FT Style
EMA1000SFR-FT	8	Auger S/F Rock D=1000mm FT Style
EMA1200SFR-FT	8	Auger S/F Rock D=1200mm FT Style

~ All sizes can be made to customer's requirements ~

## AUGERS L/F ROCK FLAT TOOTH STYLE\*

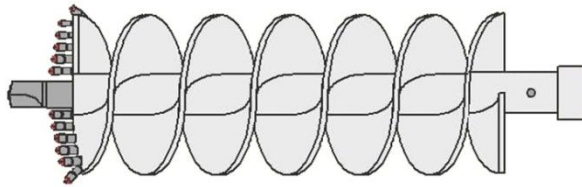

Auger Diameter	Lead Flight	Carry Flight
300mm - 500mm	16mm	12mm
600mm - 900mm	20mm	16mm (N/A on 900mm)
1200mm - 1500mm	25mm	N/A

\* For spare parts please refer to EM Auger Tools & Accessories Section

### Designation System

Part Number	Stock Code	Description
EMA300LFR-FT	8	Auger L/F Rock D=300mm FT Style
EMA350LFR-FT	8	Auger S/F Rock D=350mm FT Style
EMA400LFR-FT	8	Auger L/F Rock D=400mm FT Style
EMA450LFR-FT	8	Auger L/F Rock D=450mm FT Style
EMA500LFR-FT	8	Auger L/F Rock D=500mm FT Style
EMA550LFR-FT	8	Auger L/F Rock D=550mm FT Style
EMA600LFR-FT	8	Auger L/F Rock D=600mm FT Style
EMA650LFR-FT	8	Auger L/F Rock D=650mm FT Style
EMA700LFR-FT	8	Auger L/F Rock D=700mm FT Style
EMA750LFR-FT	8	Auger L/F Rock D=750mm FT Style
EMA800LFR-FT	8	Auger L/F Rock D=800mm FT Style
EMA900LFR-FT	8	Auger S/F Rock D=900mm FT Style
EMA1000LFR-FT	8	Auger L/F Rock D=1000mm FT Style
EMA1200LFR-FT	8	Auger L/F Rock D=1200mm FT Style

~ All sizes can be made to customer's requirements ~

## AUGER HEADS\*

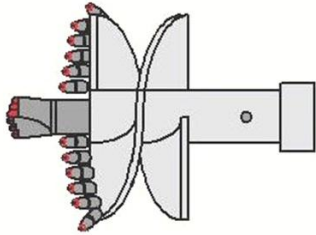

Auger Diameter	Lead Flight	Carry Flight
300mm - 500mm	16mm	12mm
600mm - 900mm	20mm	16mm (N/A on 900mm)
1200mm - 1500mm	25mm	N/A

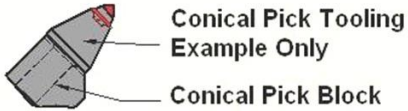

\* For spare parts please refer to EM Auger Tools & Accessories Section

### Designation System

Part Number	Stock Code	Description
<b>EMAH750SFR-CP</b>	8	Auger Head D=750mm CP Style
<b>EMAH800SFR-CP</b>	8	Auger Head D=800mm CP Style
<b>EMAH900SFR-CP</b>	8	Auger Head D=900mm CP Style
<b>EMAH1000SFR-CP</b>	8	Auger Head D=1000mm CP Style
<b>EMAH1200SFR-CP</b>	8	Auger Head D=1200mm CP Style



## AUGER RODS

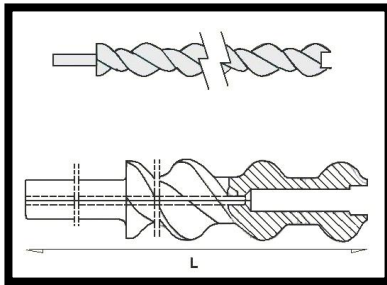







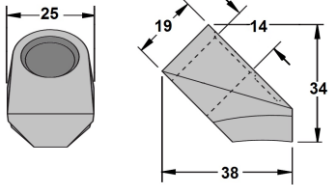

### Designation System

Part Number	Stock Code	Description
<b>RSD32-1000</b>	9	D=32mm, L=1000mm
<b>RSD40H-0700</b>	8	D=40mm, L=700mm
<b>RSD40H-0800</b>	8	D=40mm, L=800mm
<b>RSD40H-0900</b>	8	D=40mm, L=900mm
<b>RSD40H-1800</b>	8	D=40mm, L=1800mm
<b>RSD40H-1900</b>	8	D=40mm, L=1900mm
<b>RSD40H-2400</b>	8	D=40mm, L=2400mm
<b>RSD40H-2600</b>	8	D=40mm, L=2600mm
<b>RSD40S-0800</b>	1	D=40mm, L=800mm, Solid
<b>RSD40S-1200</b>	1	D=40mm, L=1200mm, Solid
<b>RSD40S-1500</b>	3	D=40mm, L=1500mm, Solid
<b>RSD40S-1800</b>	1	D=40mm, L=1800mm, Solid
<b>RSD40S-2400</b>	3	D=40mm, L=2400mm, Solid
<b>RSD40SQ-1200</b>	1	D=40mm, L=1200, M16 Sq Drive
<b>RSD40SQ-1800</b>	8	D=40mm, L=1800, M16 Sq Drive
<b>RSD40H-1200</b>	8	D=40mm, L=1200mm, Flushing hole
<b>RSD40H-1500</b>	8	D=40mm, L=1500mm, Flushing Hole
<b>RSD40H-1200TT</b>	8	D=40mm, L=1200mm, TC Protected
<b>RSD40S-1200TT</b>	8	D=40mm, L=1200mm, TC Protected
<b>RSD40S-1500TT</b>	8	D=40mm, L=1500mm, TC Protected, Solid
<b>RSD40H-1500TT</b>	8	D=40mm, L=1500mm, Flushing Hole, TC Protected
<b>RSD40H-1800TT</b>	8	D=40mm, L=1800mm, Flushing Hole, TC Protected

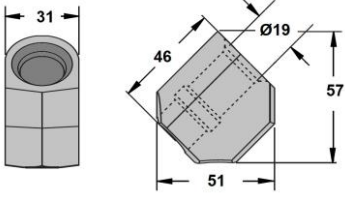

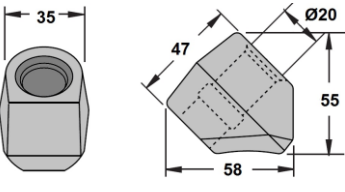
## EM &CP AUGER TOOLS & ACCESSORIES

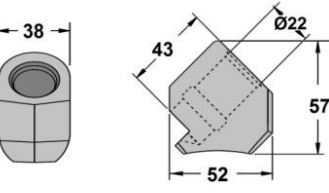
# CONICAL PICK BLOCKS

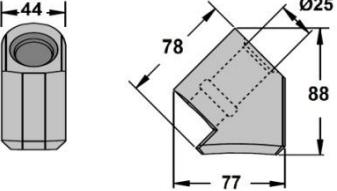
Part Number	Stock Code	Description	Drawing
<b>C055</b>	1	Conical Pick Block- 55 Ser Normal Duty 	
<b>C-1S</b>	3	Conical Pick Block-74 Ser Slim Line 	
<b>C-2S</b>	1	Conical Pick Block-76 Ser Slim Line 	
<b>C-3S</b>	1	Conical Pick Block-86 Ser Slim Line 	
<b>C-4S</b>	1	Conical Pick Block-99 Ser Normal Duty 	

## CONICAL EXTRACTION TOOLS



Part Number	Stock Code	Description	Drawing
<b>CP-12P2</b>	1	Conical Pick-Extraction Punch Suit 074/076/086 and 099 Picks	
<b>CP-12T</b>	1	Conical Extraction Tool Suit C-2/ 074/076 Picks	
<b>CP-12RP</b>	1	Conical Pick-Extraction Tool Suit 086 Picks	

# CONICAL PICKS

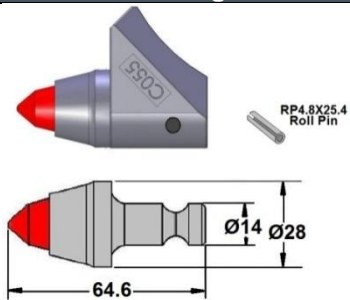



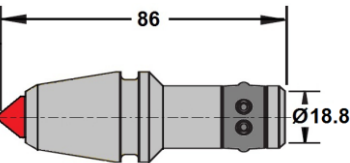

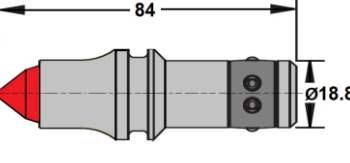



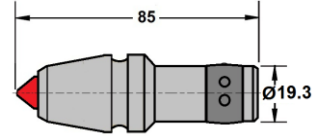

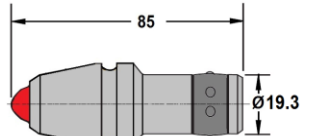
## CONICAL PICK - 55

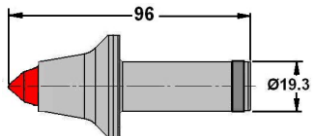
Part Number	Stock Code	Description	Drawing
<p><b>CP01</b> (CP055FB-16DCC-RPR)</p>	1	<p>Conical- 55 Full Body 16mm Cone Cap</p> 	

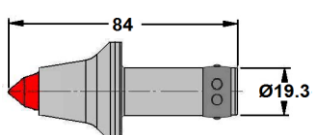

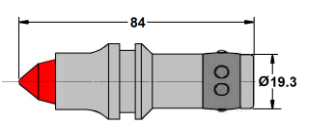

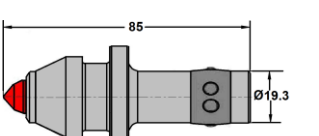

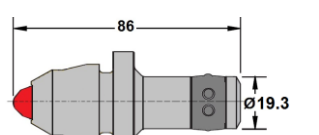
## CONICAL PICK- 74

Part Number	Stock Code	Description	Drawing
<p><b>CP06</b> (CP074GNB-12SCI-SR)</p>	1	<p>Conical- 74 Ser Grooved/Narrow Body 12mm S/Cone Insert</p> 	
<p><b>CP07</b> (CP074GNB-16DCC-SR)</p>	1	<p>Conical- 74 Ser Grooved/Narrow Body 16mm D/Cone Cap</p> 	

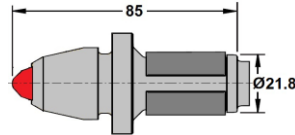

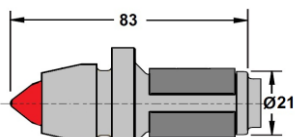

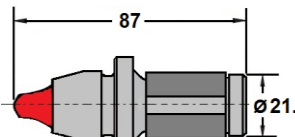

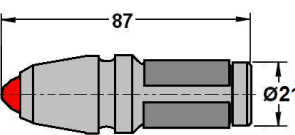



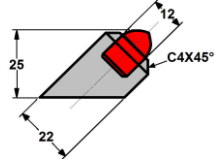

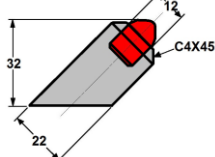

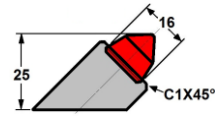

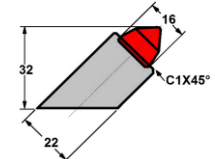
## CONICAL PICK- 76

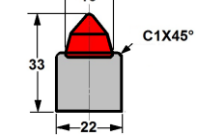
Part Number	Stock Code	Description	Drawing
<b>CP19</b> (CP076GNB-12SCI-SR)	1	Conical- 76 Ser Grooved Narrow Body 12mm S/Cone Insert 	
<b>CP20</b> (CP076GNB-12DCI-SR)	1	Conical- 76 Ser Grooved Narrow Body 12mm Cone Insert 	
<b>CP21</b> (CP076FB-16DCC-CR)	1	Conical- 76 Ser Full Body 16mm D/Cone Cap 	
<b>CP22</b> (CP076FB-16DCC-SR)	1	Conical- 76 Ser Full Body 16mm D/Cone Cap 	
<b>CP23</b> (CP076GNB-16DCC-SR)	1	Conical- 76 Ser Grooved Narrow Body 16mm D/Cone Cap 	
<b>CP24</b> (CP076GFB-16DCC-SR)	1	Conical- 76 Ser Full Body 16mm D/Cone Cap 	
<b>CP25</b> (CP076GFB-12DCI-SR)	1	Conical- 76 Ser Grooved Flanged Body 12mm Cone Insert 	

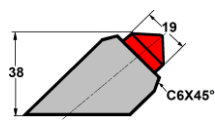
## CONICAL PICK- 86

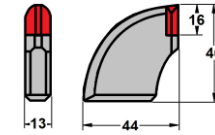

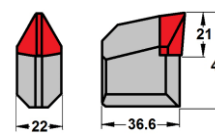

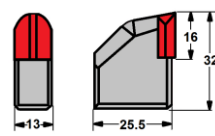

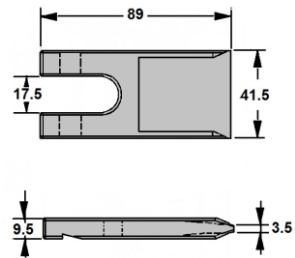

Part Number	Stock Code	Description	Drawing
<p><b>CP31</b> (CP086GFB-12DCI-LR)</p>	1	<p>Conical- 86 Ser Flanged Head Body 12mm Cone Insert</p> 	
<p><b>CP32</b> (CP086GFB-16DCC-LR)</p>	3	<p>Conical- 86 Series Flanged Head Body 16mm D/Cone Cap</p> 	
<p><b>CP33</b> (CP086GFB-18BC-LR)</p>	1	<p>Conical- 86 Series Flanged Head Body 18mm Bell Cap</p> 	
<p><b>CP36</b> (CP086GNB-12DCI-LR)</p>	3	<p>Conical- 86 Ser Grooved Narrow Body 12mm Cone Insert</p> 	

## WEAR PROTECTION WELD ON TEETH

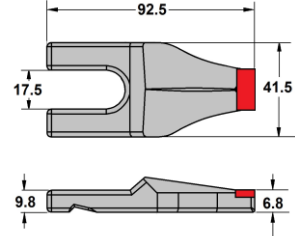

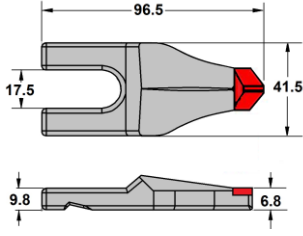

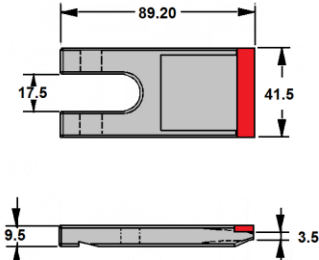

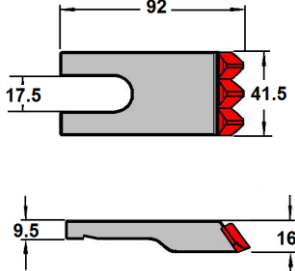



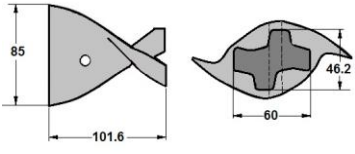

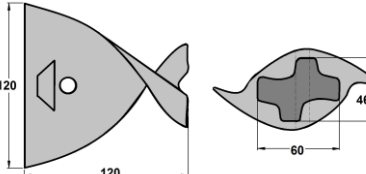
Part Number	Stock Code	Description	Drawing
<b>WT1225-45</b> (HDD-12DCI-25-45)	1	Weld On 12mm Insert Tooth H=25mm 	
<b>WT1232-45</b> (HDD-12DCI-32-45)	1	Weld On 12mm Insert Tooth H=32mm 	
<b>WT1625-45</b> (HDD-16DCC-25-45)	1	Weld On 16mm Cap Tooth H=25mm 	
<b>WT1632-45</b> (HDD-16DCC-32-45)	1	Weld On 16mm Cap Tooth H=32mm 	
<b>WT1633-90</b> (HDD-16DCC-33-90)	1	Weld On 16mm Cap H=33mm Angle=90 	
<b>WT1938-45</b> (HDD-19PI-38-45)	3	Weld On 19mm Insert Tooth H=38mm 	
<b>EM405</b>	1	Weld-On Tooth - 90° W=13, H=46 	
<b>EM405-22</b>	1	Weld-On Tooth - W=22, H=45 	
<b>EM405-S</b>	1	Weld-On Tooth - W=13, H=32 	

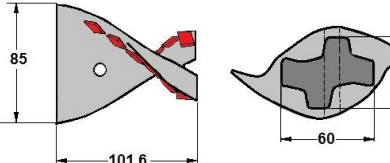

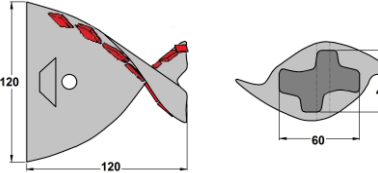

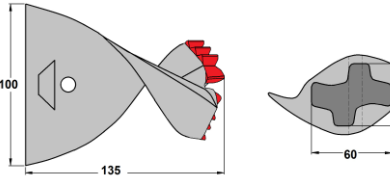

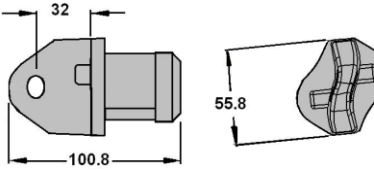
# EMF FLAT & FISHTAIL AUGER PARTS

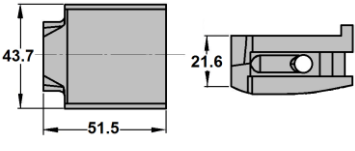
Part Number	Stock Code	Description	Drawing
<b>EMF505</b>	1	35 Series Plain Dirt Tooth 	
<b>EMF508</b>	1	35 Series TC Chisel 	
<b>EMF509</b>	1	35 Series HD Chisel – FW 	
<b>EMF527</b>	1	35 Series TC Tooth 	
<b>EMF535</b>	1	35 Series HD TC Tooth 	



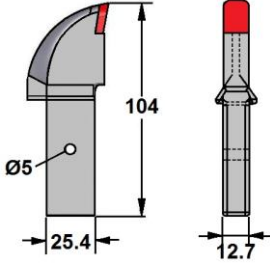

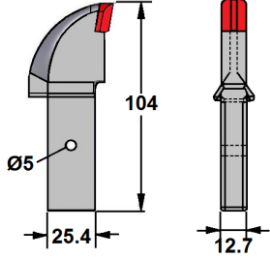

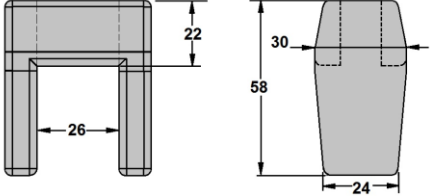



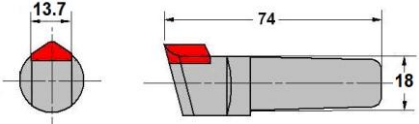

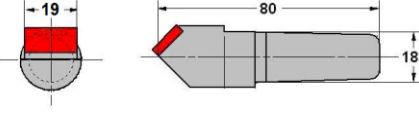

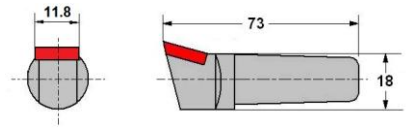
# EMF FLAT & FISHTAIL AUGER PARTS

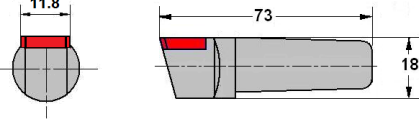
Part Number	Stock Code	Description	Drawing
<b>EMF580</b>	1	SB35 Plain Fish Tail Pilot 	
<b>EMF590</b>	1	SB45 Plain Fishtail Pilot 	
<b>EMF610</b>	1	SB35 TC Fish Tail Pilot 	
<b>EMF611</b>	3	SB45 TC Fish Tail Pilot 	
<b>EMF612</b>	1	SB35 HD TC Fish Tail Pilot 	
<b>EMF635</b>	1	SB35 Weld On Drive Lug 	
<b>EMF660</b>	1	35 Series Tooth Holder (T36) 	

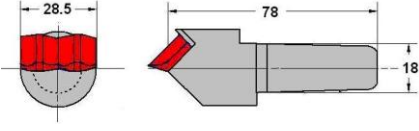

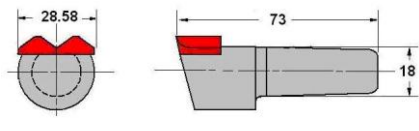

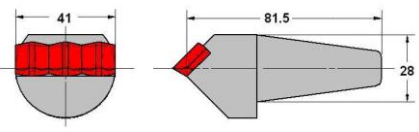

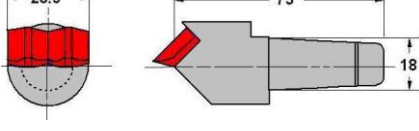



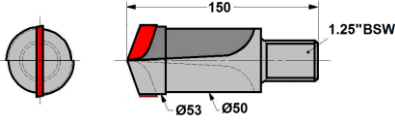

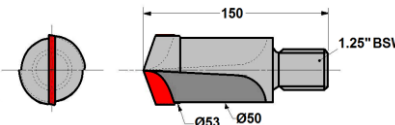

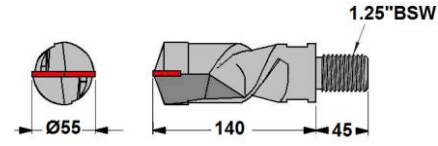
# FLAT CUTTER PICKS & BLOCKS

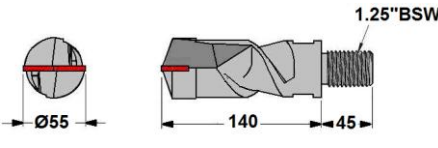
Part Number	Stock Code	Description	Drawing
<b>EM410A-F</b>	1	Flat Cutter Pick (SC-04) 	
<b>EM410A-P</b>	1	Flat Cutter Pick-New (FW8B) 	
<b>F-2S</b>	1	Flat Cutter Pick Block- (CJ2B) And EM410 	

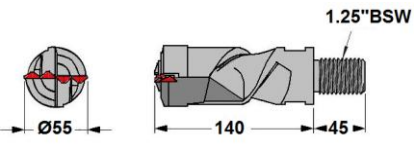

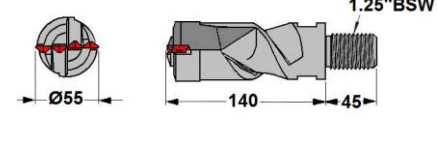

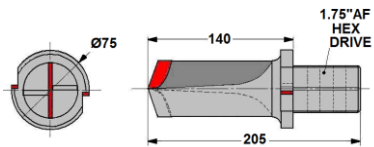

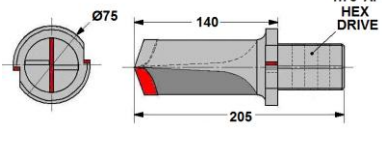



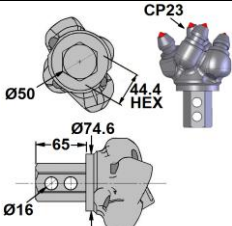

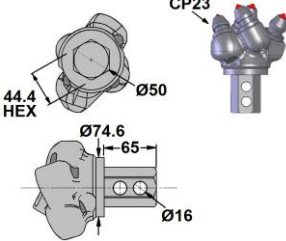
# TAPER FIT AUGER TEETH

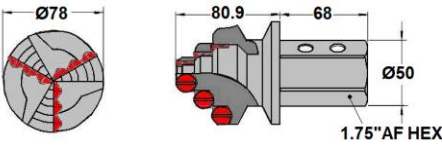
Part Number	Stock Code	Description	Drawing
EM4	1	Rock Auger tooth 	
EM5	1	Earth Auger bit 	
EM6	1	Shale bit 	
EM6N	3	Shale Bit Neutral Rake 	
EM20	1	Auger bit- 45 degrees double tip 	
EM21	1	Auger bit- 90 degrees double tip 	
EM24	1	Rock Auger Bit 	
EM25	1	Auger bit - 45 degrees double tip small taper 	

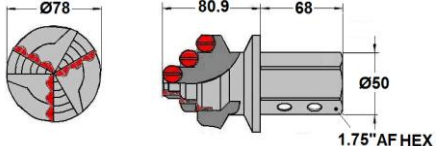

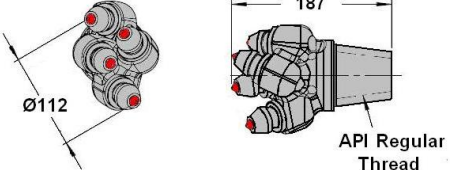

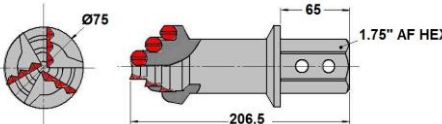

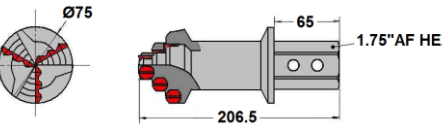
# CENTRE BITS

Part Number	Stock Code	Description	Drawing
<b>EM8L-HD</b>	3	L/H Centre Bit, L=100mm 	
<b>EM8R-HD</b>	1	R/H Centre Bit, L=100mm Heavy Duty 	
<b>EM8AL-S</b>	1	L/H Centre Bit, L=140mm Spiral Flute 	
<b>EM8AR-S</b>	1	R/H Centre Bit, L=140mm Spiral Flute 	
<b>EM8AL-SF</b>	1	L/H Centre Bit, L=140mm, Spiral Flute MF style 	
<b>EM8AR-SF</b>	1	R/H Centre Bit L=140mm Spiral MF Style 	
<b>EM8AL-HHD</b>	1	L/H Centre Bit, L=140mm Hex drive 	
<b>EM8AR-HHD</b>	1	R/H Centre Bit, L=140mm Hex drive 	

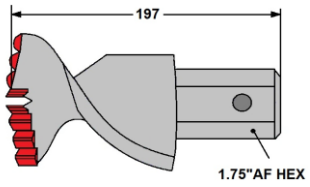

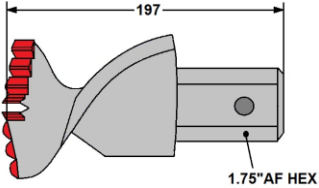

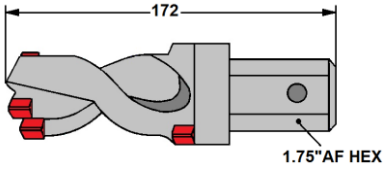
# CENTRE BITS

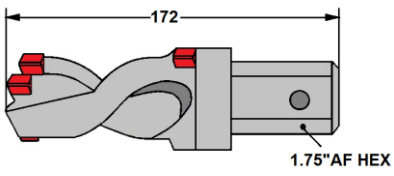
Part Number	Stock Code	Description	Drawing
<b>EM8RCP-H</b>	1	CP Centre Bit- Right Hand 	
<b>EM8LCP-H</b>	1	CP Centre Bit- Left Hand 	
<b>EM8R-HHD</b>	1	R/H, L=80mm Hex drive (Xmas tree) 	
<b>EM8L-HHD</b>	1	Centre Bit L/H, L=80mm Hex (Xmas tree) 	
<b>EM8RCP-TCF</b>	8	R/H Centre Bit CP Style- Threaded & Centre Flush 	
<b>EM8XL-HHD</b>	1	Centre Bit L/H, 	
<b>EM8XR-HHD</b>	1	R/H Centre Bit 	

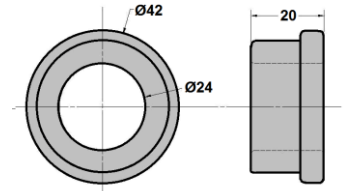

# 1 3/4" AF HEX CENTRE BITS

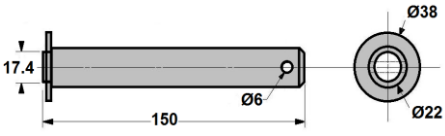
Part Number	Stock Code	Description	Drawing
<b>EMF615-R</b>	6	HD TC Fish Tail Pilot With Hex Drive RH Rotation 	
<b>EMF615-L</b>	6	HD TC Fish Tail Pilot With Hex Drive LH Rotation 	
<b>EMF622-R</b>	6	Standard Pilot Bit With Hex Drive RH Rotation 	
<b>EMF622-L</b>	6	Standard Pilot Bit With Hex Drive LH Rotation 	

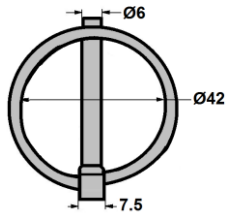
## DRIVE PIN LOCATION BUSH



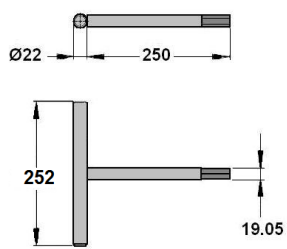

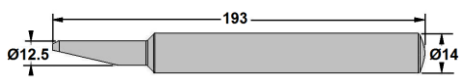

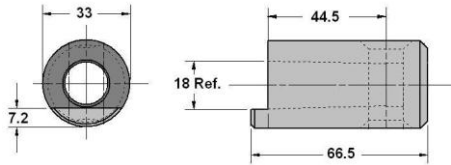

Part Number	Stock Code	Description	Drawing
<b>EM9</b>	1	Drive Pin Location Bush For Auger Shaft 	
<b>EM10</b>	1	Drive location pin with clip 	
<b>EM10CP</b>	1	Clip Pin 	

## PROLINE TOOLS

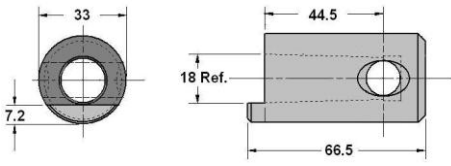

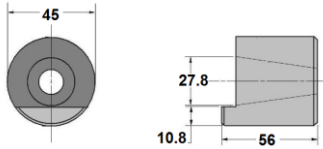

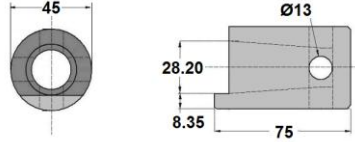

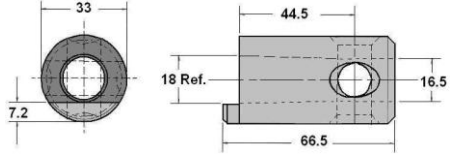
Part Number	Stock Code	Description	Drawing
<b>EM11</b>	1	Proline holder reaming tool	
<b>EM12-14</b>	1	Proline Ejector 	



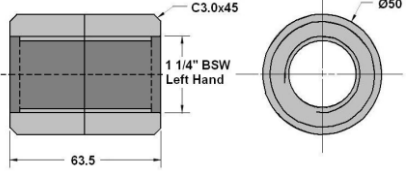

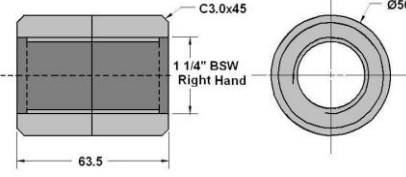

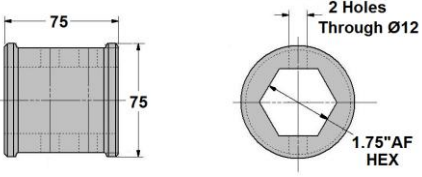
# TAPER HOLDERS

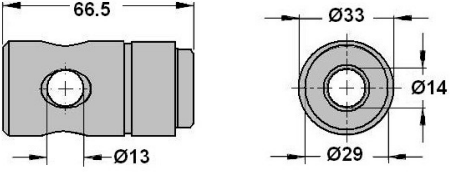
Part Number	Stock Code	Description	Drawing
<b>EM37</b>	8	N/S MT2 Holder H7897 	
<b>EM38</b>	1	E/W MT2 Holder H7544 	
<b>EM39</b>	1	Holder for EM24 	
<b>EM39U</b>	8	Universal Holder for EM24 	
<b>EM58</b>	1	Universal MT2 Holder 	

# EM HOLDERS

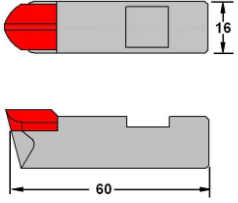
Part Number	Stock Code	Description	Drawing
<b>EM59A</b>	1	Boss L/H (W Groove) 	
<b>EM59B</b>	1	Boss R/H 	
<b>EM59C</b>	1	Boss Hex- 44.5mm AF 	
<b>EM68</b>	8	EM25 Universal Holder 	

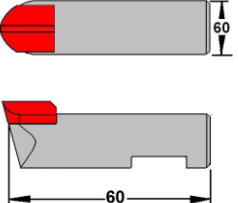
# ROCK BITS

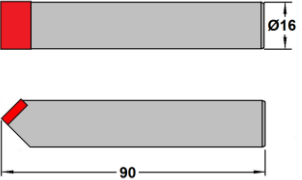
Part Number	Stock Code	Description	Drawing
<b>MRT60F</b>	1	Rock Bit - 5/8 Rd Shank FW8B Tip 	
<b>WT60F</b>	1	Rock Bit - 16mm (PIZ0125R) 	
<b>WT90-1180</b>	3	Earth Bit - 16mm (PIZ0125G) 	

## WING BITS

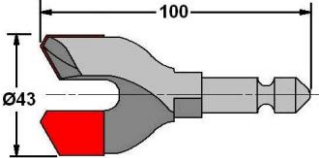
Item Number	Item Class	Description	Drawing
RE43	1	2 Wing Bit 43mm Dia-Red	 A technical drawing of a 2-wing drill bit. The bit is shown in a perspective view, highlighting its two cutting edges. The cutting edges are colored red, while the rest of the bit is grey. Dimension lines indicate a total length of 100 mm and a diameter of 43 mm, labeled as Ø43.

**Disclaimer:** While every care was taken in preparing this catalogue, Hard Metals Australia cannot accept any liability for accuracy of the information supplied.

# HARDMETALS



## CONTACT US

### HEAD OFFICE

2/35 King Road  
Hornsby NSW 2077  
Sydney Australia

T +612 9476 6333  
F +612 9476 5033

E [sales@hardmetals.com](mailto:sales@hardmetals.com)  
W [www.hardmetals.com](http://www.hardmetals.com)

### VICTORIA

T 1300 367 113  
F 03 9786 5548

